

preferred  
**DARK**  
TOOL

**Viabizzuno** progettiamo la luce

# peled soffitto antoni arola 2008

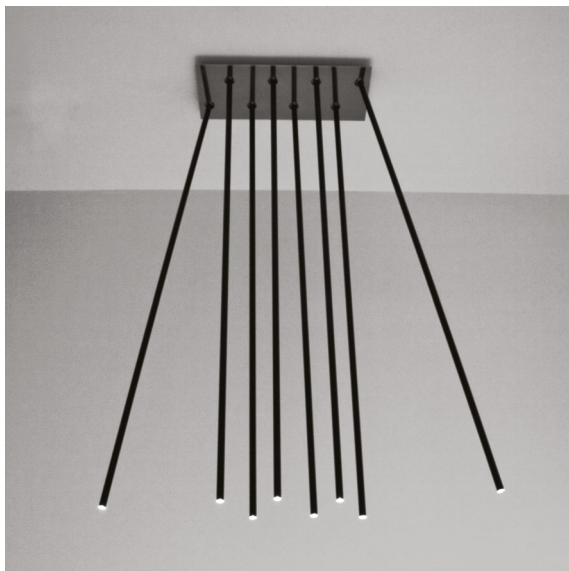

**apparecchio di illuminazione a soffitto per interni.**  
**realizzato con aste in estruso di alluminio diametro Ø14mm/0.5'' 1200mm/47.2'' collegate a piastra di supporto in acciaio 170x170x40mm/6.7x6.7x1.6'' con uno snodo sferico che permette una inclinazione fino a 30° rispetto all'asse verticale.**

**modelli:**

**peled soffitto con 1 asta,**  
**peled soffitto con 4 aste,**  
**peled soffitto con 8 aste.**  
**cablato con sorgente elettronica 3000K Ra98 1W.**  
**alimentatore 120V 50-60Hz incluso.**

**accessori: giunto, piastra frontale per 1, 4, 8 e 16 aste.**

**finiture: piastra in inox lucido, nero lucido e bianco V, aste in alluminio verniciato nero lucido, bianco V e argento antico.**

**dry location rated ceiling light fitting for indoor use. made of extruded aluminium rods with a diameter Ø14mm/0.5'' 1200mm/47.2'' connected to a 170x170x40mm/6.7x6.7x1.6'' steel support plate with a spherical joint that allows an inclination up to 30° on the vertical axis.**

**versions:**

**peled soffitto with 1 rod,**  
**peled soffitto with 4 rods,**  
**peled soffitto with 8 rods.**  
**wired with 3000K Ra98 1W led source.**  
**120V 50-60Hz power supply included.**

**accessories: joint, front plate for 1, 4, 8 and 16 rods.**

**finishes: bianco V, polished black and polished stainless steel plate, aluminium rods painted in polished black, bianco V and antique silver.**

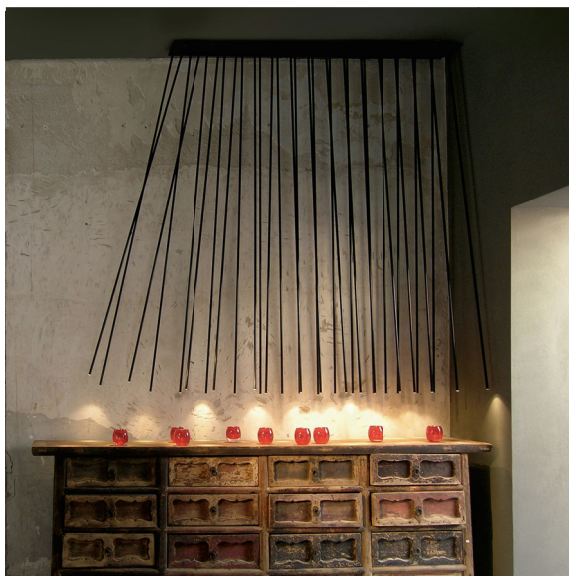

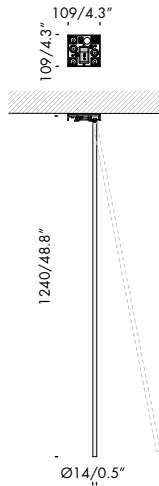

**peled soffitto 1** 120V 50-60Hz dry

<b>α6.500.21.u</b>	bianco V	3000K	1,3kg 2.9lb
<b>α6.500.23.u</b>	argento antico · antique silver	3000K	1,3kg 2.9lb
<b>α6.500.25.u</b>	nero lucido · polished black	3000K	1,3kg 2.9lb

Ra		ies tm-30		sdc	mA	V <sub>f (min)</sub>	lm	W	lm/W	
90		Rf 90	Rg 100	step 2	350	3,0	79	1	79	<b>A++</b>
ca041	les2	Ta25 °C		vita media · average life		50000 h	L80	B10		

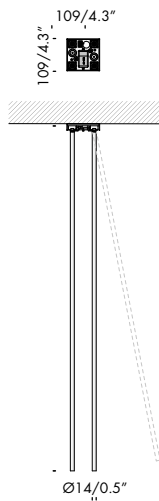

**peled soffitto 4** 120V 50-60Hz dry

<b>α6.500.01.u</b>	bianco V	3000K	4x1W	1,5kg 3.3lb
<b>α6.500.03.u</b>	argento antico · antique silver	3000K	4x1W	1,5kg 3.3lb
<b>α6.500.05.u</b>	nero lucido · polished black	3000K	4x1W	1,5kg 3.3lb

Ra		ies tm-30		sdc	mA	V <sub>f (min)</sub>	lm	W	lm/W	
90		Rf 90	Rg 100	step 2	350	12,0	316	4	79	<b>A++</b>
ca041-4	les2	Ta25 °C		vita media · average life		50000 h	L80	B10		



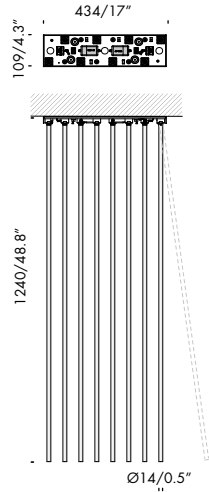

**peled soffitto 8**

120V 50-60Hz 

dry   

<b>a6.500.11.u</b>	bianco V	3000K	8x1W	4,3kg 9.5lb
<b>a6.500.13.u</b>	argento antico · antique silver	3000K	8x1W	4,3kg 9.5lb
<b>a6.500.15.u</b>	nero lucido · polished black	3000K	8x1W	4,3kg 9.5lb

Ra	ies tm-30		sdc	mA	V <sub>f (min)</sub>	lm	W	lm/W	
90	Rf 90	Rg 100	step 2	350	24,0	632	8	79	<b>A++</b>
ca041-8	les2	Ta25 °C	vita media · average life	50000 h	L80	B10			



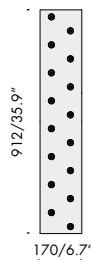
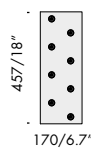
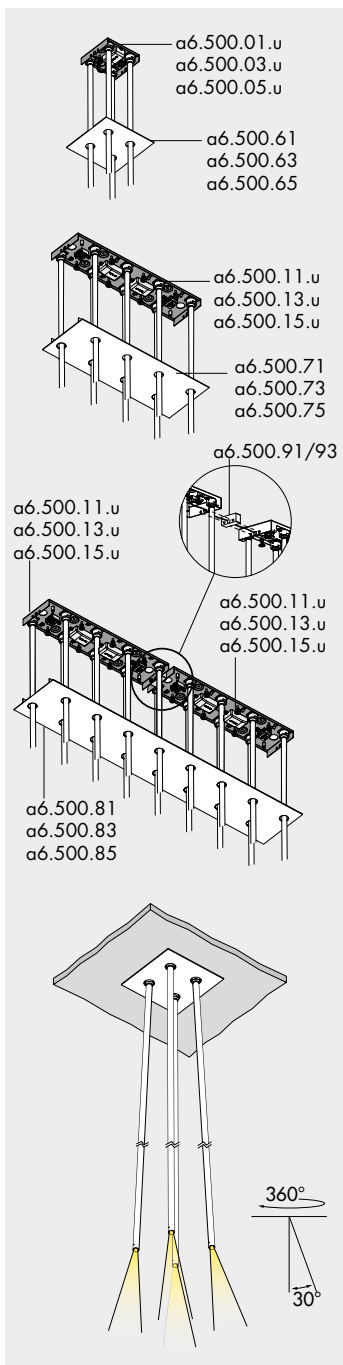

#### piastre. plates.



<b>a6.500.51</b>	acciaio lucido · polished steel	1 modulo · module	0,9kg 2lb
<b>a6.500.52</b>	nero lucido · polished black	1 modulo · module	0,9kg 2lb
<b>a6.500.53</b>	bianco V	1 modulo · module	0,9kg 2lb
<b>a6.500.61</b>	acciaio lucido · polished steel	4 moduli · modules	0,9kg 2lb
<b>a6.500.63</b>	nero lucido · polished black	4 moduli · modules	0,9kg 2lb
<b>a6.500.65</b>	bianco V	4 moduli · modules	0,9kg 2lb
<b>a6.500.71</b>	acciaio lucido · polished steel	8 moduli · modules	1,7kg 3.8lb
<b>a6.500.73</b>	nero lucido · polished black	8 moduli · modules	1,7kg 3.8lb
<b>a6.500.75</b>	bianco V	8 moduli · modules	1,7kg 3.8lb
<b>a6.500.81</b>	acciaio lucido · polished steel	16 moduli · modules	3,3Kg 7.3lb
<b>a6.500.83</b>	nero lucido · polished black	16 moduli · modules	3,3Kg 7.3lb
<b>a6.500.85</b>	bianco V	16 moduli · modules	3,3Kg 7.3lb

#### giunti lineari. linear joints.



<b>a9.500.91</b>	nero · black	0,1kg 0.22lb
<b>a9.500.93</b>	bianco · white	0,1kg 0.22lb

